

GS BASIC 22S4 800X525

Entry level hand pallet truck (2.200 kg)



GS BASIC

The GS Basic pallet truck is the entry model of the Lifter hand pallet truck range, featuring reliability and solidness at competitive pricing.



HYDRAULIC UNIT

Resistant and reliable one piece cast iron pump, worked with numerical control machine, including:

- Maximum pressure valve: safety device that ensures the transpallet against overloads. When the pressure inside the hydraulic circuit exceeds the set calibration value according to the maximum nominal flow, the valve automatically locks the forks.
- ON/OFF lowering valve



STANDARD CONFIGURATION

- Nylon - Poly 45 steering wheels
- Nylon rollers
- 2 Curves handle with all the controls (lowering / drive position / lifting) available in a single lever for simple and safe control



VARNISHING

Following an appropriate conditioning operation the frame is varnished with polyester powder at a temperature of 250° to guarantee maximum resistance to wear and atmospheric agents.



OPTIONAL CONFIGURATION

- Nylon steering wheels
- Nylon - Poly 55 steering wheels
- Aluminium - Rubber steering wheels



- Polyurethane rollers



- Manual control brake. The brake of the pallet truck, available with rubber steering wheels, is adjustable through the tiller lever to ensure safe use on slopes and ramps. The locking function makes it possible to park the pallet truck even on slopes without rolling away.



Descriere

1.1 Producător			LIFTER
1.3 Comandă			Manual
1.4 Poziție operare			Pedestru
1.5 Capacitate maximă	Q	Kg	2200
1.6 Distanța la centrul de aplicare al sarcinii	c	mm	400
1.8 Sarcina de la osie la capătul furcilor	x	mm	582
1.9 Ampatament	y	mm	842

Greutăți

2.1 Greutate de operare		Kg	57
2.2 Sarcină osie, încărcare pe spate		Kg	1580
2.2 Sarcină osie, încărcare pe față		Kg	677
2.3 Sarcină osie, liber spate		Kg	18
2.3 Sarcină osie, liber față		Kg	39

Cauciucuri/Șasiuri

3.2 Mărime cauciuc: roți direcție - Diametru		mm	200
3.2 Mărime cauciuc: roți direcție - Lățime		mm	45
3.3 Mărime cauciuc: transportoare cu role - Diametru		mm	82
3.3 Mărime cauciuc: transportoare cu role - Lățime		mm	60
3.5 Dimensiune cauciuc: roți spate		nr	4
3.5 Ax de echilibru spate			No
3.6 Ecartament, față	b10	mm	155
3.7 Ecartament, spate	b11	mm	375

Dimensiuni

4.4 Înălțime stivuitor	h3	mm	115
4.9 Înălțime manetă în poziția de deplasare, max	h14	mm	1160
4.15 Înălțime, coborât	h13	mm	85
4.19 Lungime globală	l1	mm	1200
4.20 Distanța până la suprafața frontală a furcilor	l2	mm	400
4.21 Lățime globală	b1	mm	525
4.22 Dimensiuni furcă - grosime	s	mm	55
4.22 Dimensiuni furcă - Lățime	e	mm	150
4.22 Dimensiuni furcă - Lungime	l	mm	800
4.25 Distanța între furci	b5	mm	525
4.32 Gardă la sol și mijloc ampatament	m2	mm	30
4.34 Lățime culoar	Ast	mm	1435
4.35 Rază de virare	Wa	mm	1017

Performante

5.2 Viteză de ridicare, încărcat	strokes		13
5.2 Viteză de ridicare, descărcat	strokes		13

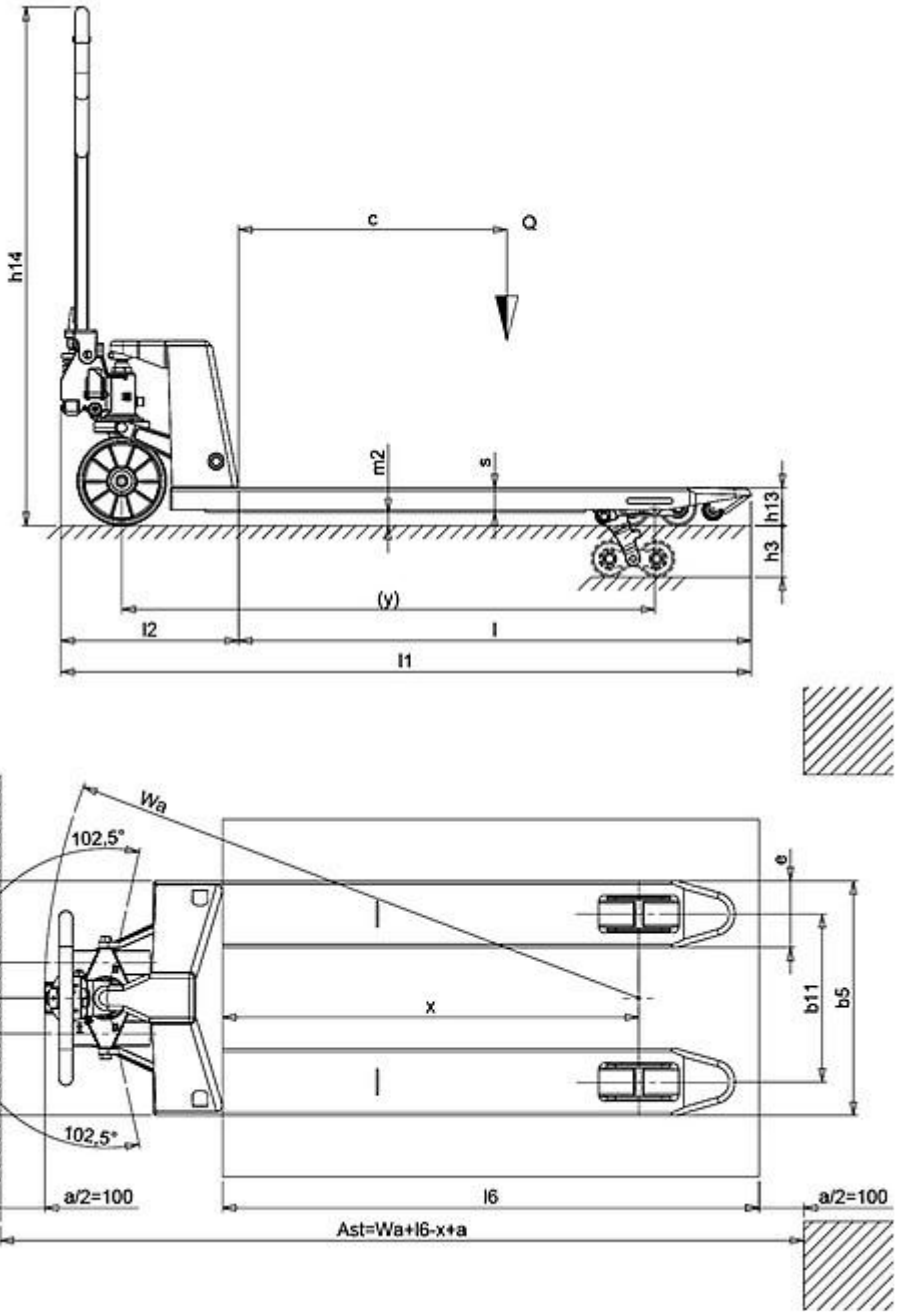

The information is aligned with the Data file at the time of download. Printed on 23/02/2020 (ID 526)

©2019 | PR INDUSTRIAL s.r.l. | All rights reserved | Image shown may not reflect actual package. Specifications subject to change without notice

